

AND

Digital Blood Pressure Monitor

Model UA-651BLE

Instruction Manual
Original

ENGLISH

Manuel d'instructions
Traduction

FRANÇAIS

Manual de Instrucciones
Traducción

ESPAÑOL

Manuale di Istruzioni
Traduzione

ITALIANO

Bedienungsanleitung
Übersetzung

DEUTSCH

使用手冊
翻譯

中文



1WMPD4003018C

Contents

Dear Customers	2
Preliminary Remarks	2
Precautions	2
Parts Identification	5
Symbols	6
Using the Monitor.....	8
Installing / Changing the Batteries	8
Connecting the Air Hose	8
Connecting the AC Adapter.....	8
Wireless Function.....	9
<i>Bluetooth</i> [®] Transmission	9
Pairing	10
Selecting the Correct Cuff Size	12
Applying the Arm Cuff	13
How to Take Accurate Measurements	13
Measurement.....	13
After Measurement	13
Measurements.....	14
Normal Measurement.....	14
Measurement with the Desired Systolic Pressure	15
Notes for Accurate Measurement	15
What Is The IHB/AFib Indicator?.....	16
What Is The AFib?	16
Pressure Bar Indicator.....	16
About Blood Pressure	17
What is Blood Pressure?	17
What is Hypertension and How is it Controlled?.....	17
Why Measure Blood Pressure at Home?.....	17
WHO Blood Pressure Classification	17
Blood Pressure Variations.....	17
Troubleshooting.....	18
Maintenance.....	19
Technical Data.....	19

Dear Customers

Congratulations on purchasing a state-of-the-art A&D blood pressure monitor, one of the most advanced monitors available today. Designed for ease of use and accuracy, this monitor will facilitate your daily blood pressure regimen.

We recommend that you read through this manual carefully before using the device for the first time.

The *Bluetooth*® word mark and logos are registered trademarks owned by Bluetooth SIG, Inc. and any use of such marks by A&D is under license. Other trademarks and trade names are those of their respective owners.

Preliminary Remarks

- ❑ This device conforms to the European Directive 93/42 EEC for Medical Products. This is made evident by the **CE**₀₁₂₃ mark of conformity. (0123: The reference number to the involved notified body)
- ❑ Hereby, A&D Company, Limited declares that the radio equipment type UA-651BLE is in compliance with Directive 2014/53/EU. The full text of the EU declaration is available at the following internet address: http://www.aandd.jp/products/manual/manual_medical.html
- ❑ The device is a Continua certified, *Bluetooth*® wireless technology enabled medical device.
- ❑ The device is designed for use on adults, not newborns or infants.
- ❑ Environment for use. The device is for use to operate by yourself in the home healthcare environment.
- ❑ This device is designed to measure blood pressure and pulse rate of people for diagnosis.

Precautions

- ❑ Precision components are used in the construction of this device. Extremes in temperature, humidity, direct sunlight, shock or dust should be avoided.
- ❑ Clean the device and cuff with a dry, soft cloth or a cloth dampened with water and a neutral detergent. Never use alcohol, benzene, thinner or other harsh chemicals to clean the device or cuff.
- ❑ Avoid tightly folding the cuff or storing the hose tightly twisted for long periods, as such treatment may shorten the life of the components.
- ❑ Take care to avoid accidental strangulation of babies or infants with the hose.
- ❑ Do not twist the air hose during measurement. This may cause injury due to continuous cuff pressure.
- ❑ The device and cuff are not water resistant. Prevent rain, sweat and water from soiling the device and cuff.
- ❑ Measurements may be distorted if the device is used close to televisions, microwave ovens, cellular telephones, X-ray or other devices with strong electrical fields.

- ❑ Wireless communication devices, such as home networking devices, mobile phones, cordless phones and their base stations, walkie-talkies can affect this blood pressure monitor. Therefore, a minimum distance of 30 cm should be kept from such devices.
- ❑ When reusing the device, confirm that the device is clean.
- ❑ Used equipment, parts and batteries are not treated as ordinary household waste, and must be disposed of according to the applicable local regulations.
- ❑ When the AC adapter is used, make sure that the AC adapter can be readily removed from the electrical outlet when necessary.
- ❑ Do not modify the device. It may cause accidents or damage to the device.
- ❑ To measure blood pressure, the arm must be squeezed by the cuff hard enough to temporarily stop blood flow through the artery. This may cause pain, numbness or a temporary red mark to the arm. This condition will appear especially when measurement is repeated successively. Any pain, numbness, or red marks will disappear with time.
- ❑ Measuring blood pressure too frequently may cause harm due to blood flow interference. Check that the operation of the device does not result in prolonged impairment of blood circulation, when using the device repeatedly.
- ❑ If you have had a mastectomy, please consult a doctor before using the device.
- ❑ Do not let children use the device by themselves and do not use the device in a place within the reach of infants. It may cause accidents or damage.
- ❑ There are small parts that may cause a choking hazard if swallowed by mistake by infants.
- ❑ Unplug the AC adapter when not in use during the measurement.
- ❑ Use of accessories not detailed in this manual may compromise safety.
- ❑ Should the battery short-circuit, it may become hot and potentially cause burns.
- ❑ Allow the device to adapt to the surrounding environment before use (about one hour).
- ❑ Clinical testing has not been conducted on newborn infants and pregnant woman. Do not use on newborn infants or pregnant woman.
- ❑ Do not touch the batteries, the DC jack, and the patient at the same time. That may result in electrical shock.
- ❑ Do not inflate without wrapping the cuff around the upper arm.

Contraindications

The following are precautions for proper use of the device.

- ❑ Do not apply the cuff on an arm with another medical electrical equipment attached. The equipment may not function properly.
- ❑ People who have a severe circulatory deficit in the arm must consult a doctor before using the device, to avoid medical problems.

- ❑ Do not self-diagnose the measurement results and start treatment by yourself. Always consult your doctor for evaluation of the results and treatment.
- ❑ Do not apply the cuff on an arm with an unhealed wound.
- ❑ Do not apply the cuff on an arm receiving an intravenous drip or blood transfusion. It may cause injury or accidents.
- ❑ Do not use the device where flammable gases such as anesthetic gases are present. It may cause an explosion.
- ❑ Do not use the device in highly concentrated oxygen environments, such as a high-pressure oxygen chamber or an oxygen tent. It may cause a fire or explosion.

Parts Identification

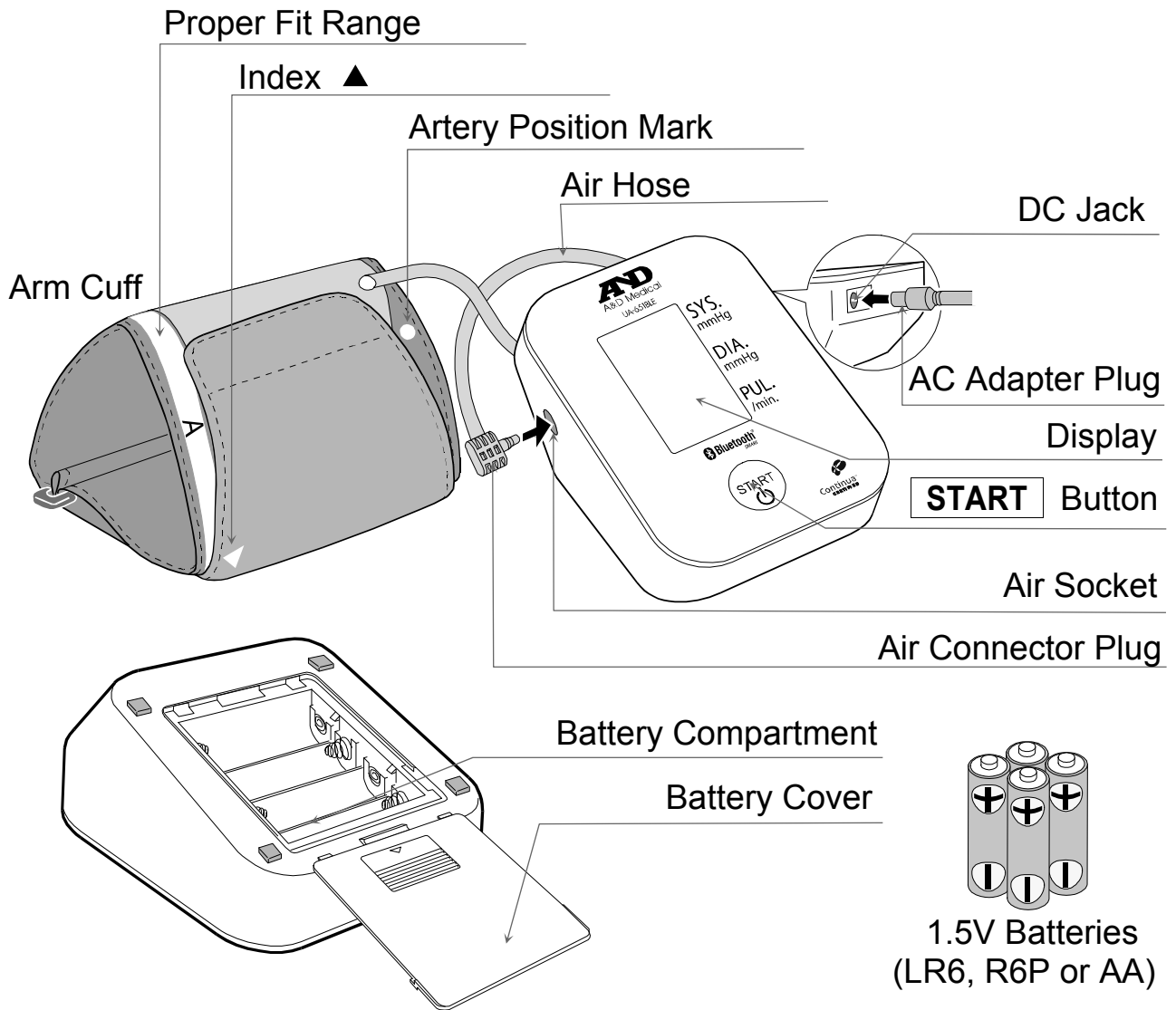



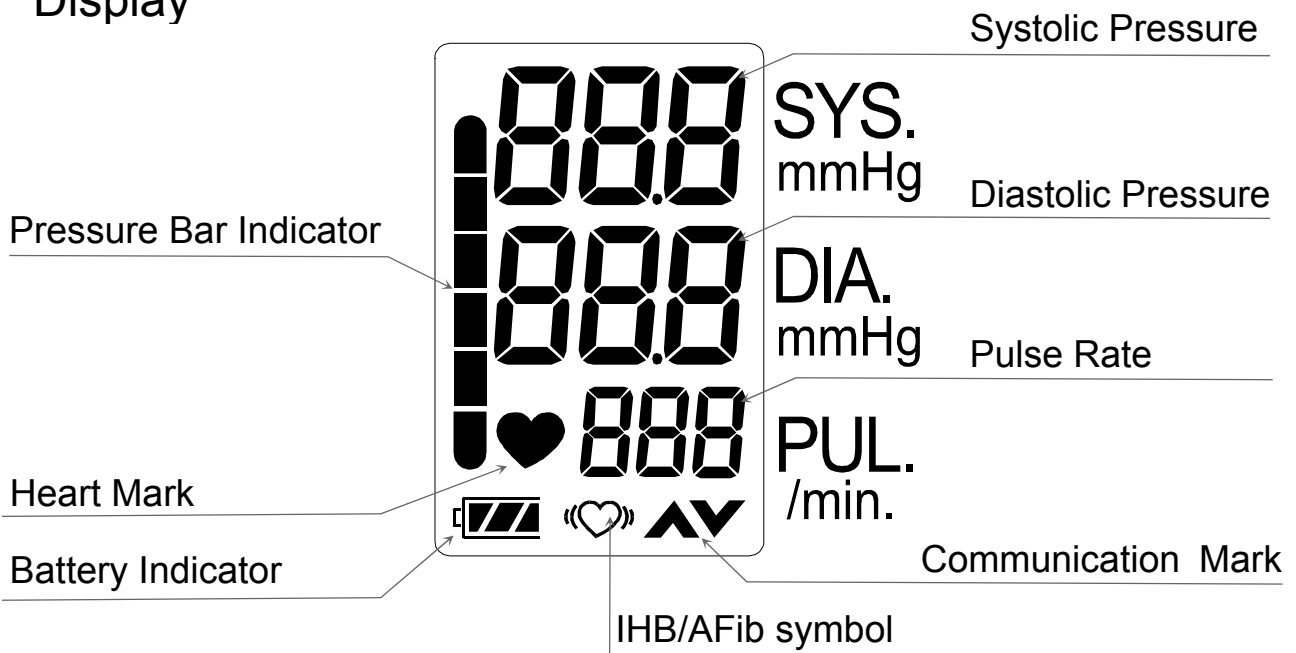





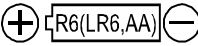

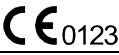
Display



Symbols

Symbols that are printed on the device case

Symbols	Function / Meaning
	Standby and Turn the device on.
SYS	Systolic blood pressure in mmHg
DIA	Diastolic blood pressure in mmHg
PUL	Pulse per minute
	Battery installation guide
	Direct current
	Type BF: Device, cuff and tubing are designed to provide special protection against electrical shocks.
	EC directive medical device label
	EU-representative
	Manufacturer
2014 	Date of manufacture
IP	International protection symbol
	WEEE label
SN	Serial number
BT	Bluetooth address
	Refer to instruction manual/booklet
	Polarity of DC jack
	To indicate generally elevated, potentially hazardous, levels of non-ionizing radiation, or to indicate equipment or systems e.g. in the medical electrical area that include RF transmitters or that intentionally apply RF electromagnetic energy for diagnosis or treatment.
	Keep dry

Symbols that appear on the display

Symbols	Function / Meaning	Recommended Action
	Appears while measurement is in progress. It blinks when the pulse is detected.	Measurement is in progress. Remain as still as possible.

Symbols	Function / Meaning	Recommended Action
	IHB/AFib symbol Appears when an irregular heartbeat is detected. It may light when a very slight vibration like shivering or shaking is detected.	_____
	▲ and ▼ are illuminated alternately during communication.	_____
	FULL BATTERY The battery power indicator during measurement.	_____
	LOW BATTERY The battery is low when it blinks.	Replace all batteries with new ones when the mark blinks.
Err	Unstable blood pressure due to movement during measurement.	Take another measurement. Remain very still during measurement.
	The systolic and diastolic values are within 10 mmHg of each other.	Apply the cuff correctly, and take another measurement.
	The pressure value did not increase during the inflation.	
Err CUFF	The cuff is not applied correctly.	Apply the cuff correctly, and take another measurement.
E	PUL DISPLAY ERROR The pulse is not detected correctly.	
Err E	Blood pressure monitor internal error	Remove the batteries and press the START button, and then install the batteries again. If the error still appears, contact the dealer.
Err g		
Err 10	Pairing has not been performed correctly.	Remove and reinstall the batteries. Try pairing again.
Err 11		
Pr	Pairing in progress.	_____
SEt		
End	Pairing complete.	_____



Using the Monitor

Installing / Changing the Batteries

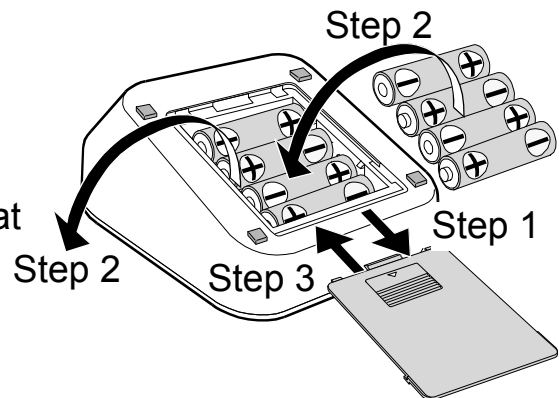
1. Remove the battery cover.
2. Remove the used batteries and insert new batteries into the battery compartment as shown, taking care that the polarities (+) and (-) are correct.
3. Replace the battery cover.
Use only LR6, R6P or AA batteries.



CAUTION

- ❑ Insert the batteries as shown in the battery compartment. If installed incorrectly, the device will not work.
- ❑ When  (LOW BATTERY mark) blinks in the display, replace all batteries with new ones. Do not mix old and new batteries. It may shorten the battery life, or cause the device to malfunction. Replace the batteries two seconds or more after the device turns off. If  (LOW BATTERY mark) appears even after the batteries are replaced, make a blood pressure measurement. The device may then recognize the new batteries.
- ❑  (LOW BATTERY mark) does not appear when the batteries are drained.
- ❑ The battery life varies with the ambient temperature and may be shorter at low temperatures. Generally, four new LR6 batteries will last approximately for one year when used twice for measurement each day.
- ❑ Use the specified batteries only. The batteries provided with the device are for testing monitor performance and may have a limited life.
- ❑ Remove the batteries if the device is not to be used for a long time. The batteries may leak and cause a malfunction.

Connecting the Air Hose

Insert the air connector plug into the air socket firmly.

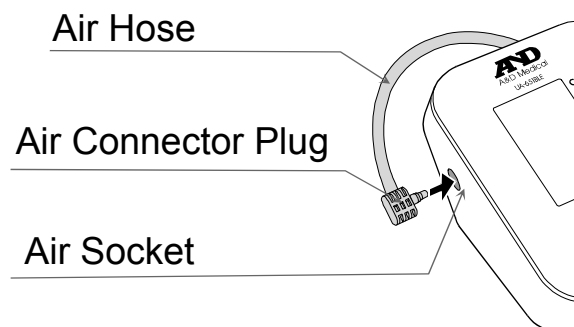

Connecting the AC Adapter

Insert the AC adapter plug into the DC jack. Next, connect the AC adapter to an electrical outlet.

- ❑ Use the specified AC adapter. (Refer to page 20.)
- ❑ When disconnecting the AC adapter from the electrical outlet, grasp and pull the AC adapter body out of the outlet.
- ❑ When disconnecting the AC adapter plug from the blood pressure monitor, grasp and pull the AC adapter plug out of the monitor.

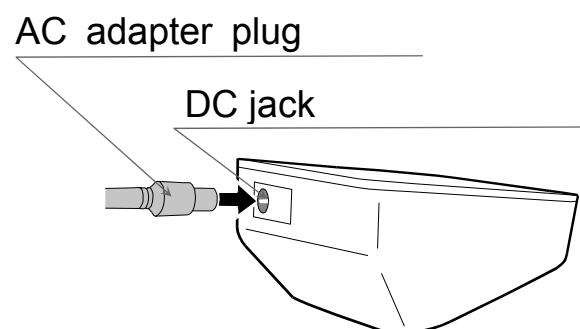

Using the Monitor

Wireless Function

CAUTION

- ❑ In the unlikely event that this monitor causes radio wave interference to a different wireless station, change the location where this monitor is used or stop use immediately.
- ❑ Be sure to use in a location where visibility between the two devices that you want to connect is good. The connection distance is reduced by the structure of buildings or other obstructions. In particular, connection may be impossible when devices are used on either side of reinforced concrete.
- ❑ Do not use *Bluetooth*® connection in the range of a wireless LAN or other wireless devices, near devices that emit radio waves such as microwaves, in locations where there are many obstructions, or in other locations where signal strength is weak. Doing so may result in frequent loss of connection, very slow communication speeds and errors.
- ❑ Using close to an IEEE802.11g/b/n wireless LAN device may cause mutual interference to occur, which may result in reduced communication speeds or which may prevent connection.
In this case, switch off the power supply to the device that is not being used, or use the monitor in a different location.
- ❑ If the monitor does not connect normally when used near a wireless station or broadcast station, use the monitor in a different location.
- ❑ A&D Company, Limited cannot accept liability for any damages incurred due to impaired operation or data loss, etc. that occur through the use of this product.
- ❑ This product is not guaranteed to connect to all *Bluetooth*® compatible devices.

Bluetooth® Transmission

This product is equipped with a *Bluetooth*® wireless function and can connect to the following *Bluetooth*® devices.

- Continua certified devices
- iPhone, iPad, iPod (iPhone 4S or later)
- Applications and devices that are compatible with Bluetooth 4.0.

Each device needs an application to receive data.

For connection methods, refer to the manual for each device.



Bluetooth® devices carry the *Bluetooth*® logo mark.



Continua certified devices carry the Continua logo mark.

To connect with your mobile device – download and install the “A&D Connect” app:



Follow the instructions in the app to connect.

Using the Monitor

Pairing

A *Bluetooth*® device needs to be paired with a different specific device in order to communicate with that device. If this monitor is paired with a receiver device from the start, measurement data is transmitted automatically to the receiver device each time a measurement is made.

Cautions for pairing

- ❑ Only one device can be paired with this monitor at one time. If the receiver device cannot receive measurement data, try pairing again
- ❑ If another receiver device is paired, the first device will be unpaired to enable the new device to be paired.

Follow the steps below to pair the monitor with a *Bluetooth*® compatible receiver device. Also refer to the manual of the receiver device. Please use a pairing wizard if one is provided.

Pairing procedure

1. Follow the instructions in the manual of the receiver device to switch it to the pairable status. When pairing this monitor, place it as close as possible to the receiver device to be paired with.
2. Install the batteries or connect the AC adapter as described on page 8.
Press and hold the **START** button until “**pr**” is displayed, and then release the button.
The monitor will be in a state that can be found by the receiver device for about one minute.
3. The monitor displays “**end**” to indicate that pairing is complete.
4. If “**err10**” is displayed or pairing is failed, remove the batteries or disconnect the AC adapter and try steps 1-3 again.
5. Follow the manual of the pairing receiver device to search for, select and pair with this monitor.

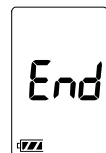
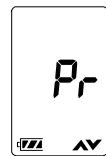

Using the Monitor

Communication distance

The communication distance between this monitor and the receiver device is about 10 m.

This distance is reduced by the conditions in the surrounding environment, so be sure to check that the distance is short enough for a connection to be made after measurement is complete.

Transmitting temporarily stored data

In cases when the receiver device cannot receive measurement data, the measurement data is temporarily stored in the monitor memory. The data stored in the memory is transmitted the next time a connection is successfully made to the receiver device.

A total of 30 sets of measurement data can be stored. When the amount of data exceeds 30 sets, the oldest data is deleted and the new data is stored. The amount of data that can be stored temporarily may vary with the application.

Time

This monitor has a built-in clock. The date and time that a measurement was taken is included in the measurement data.

The built-in clock is designed to be automatically adjusted by syncing with the clock of a receiver device. Refer to the specifications of the receiver device.

This monitor has no clock adjustment function.

Using the Monitor

Selecting the Correct Cuff Size

Using the correct cuff size is important for an accurate reading. If the cuff is not the proper size, the reading may yield an incorrect blood pressure value.

- The arm size is printed on each cuff.
- The index ▲ and proper fit range, on the cuff, tell you if you are applying the correct cuff. (Refer to "Symbols that are printed on the cuff".)
- If the index ▲ points outside of the range, contact your local dealer to purchase a replacement cuff.
- The arm cuff is a consumable. If it becomes worn, purchase a new one.

Arm Size	Recommended Cuff Size	Catalog Number
31 cm to 45 cm	Large adult cuff	CUF-F-LA
22 cm to 32 cm	Adult cuff	CUF-F-A

Arm size: The circumference of the biceps.

Note: Model UA-651BLE is not designed for using a small adult cuff.

Symbols that are printed on the cuff

Symbols	Function/Meaning	Recommended Action
●	Artery position mark	Set the ● mark on the artery of the upper arm or in line with the ring finger on the inside of the arm.
▲	Index	_____
REF	Catalog number	_____
A	Proper fit range for the adult cuff. It's printed on the adult cuff.	_____
L	Range to use the large adult cuff. Over range printed on the adult cuff.	Use the large adult cuff instead of the adult cuff.
L	Proper fit range for the large adult cuff. It's printed on the large adult cuff.	_____
S	Under range printed on the adult cuff.	_____
A	Range to use the adult cuff. It's printed on the large adult cuff.	Use the adult cuff instead of the large adult cuff.
LOT	Lot number	_____

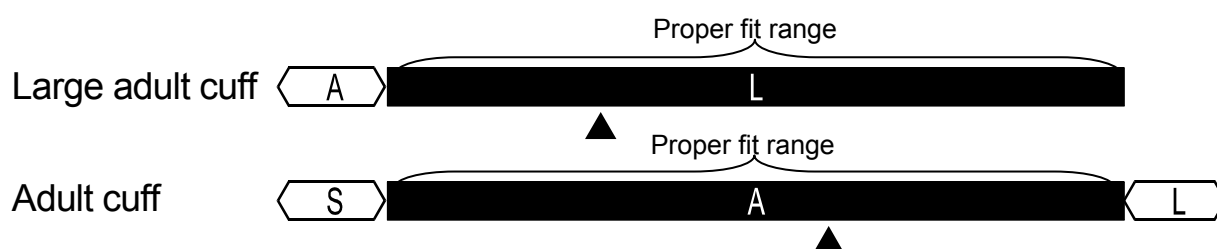

Using the Monitor

Applying the Arm Cuff

1. Wrap the cuff around the upper arm, about 1-2 cm above the inside of the elbow, as shown. Place the cuff directly against the skin, as clothing may cause a faint pulse, and result in a measurement error.
2. Constriction of the upper arm, caused by tightly rolling up a shirtsleeve, may prevent accurate readings.
3. Confirm that the index ▲ points within the proper fit range.

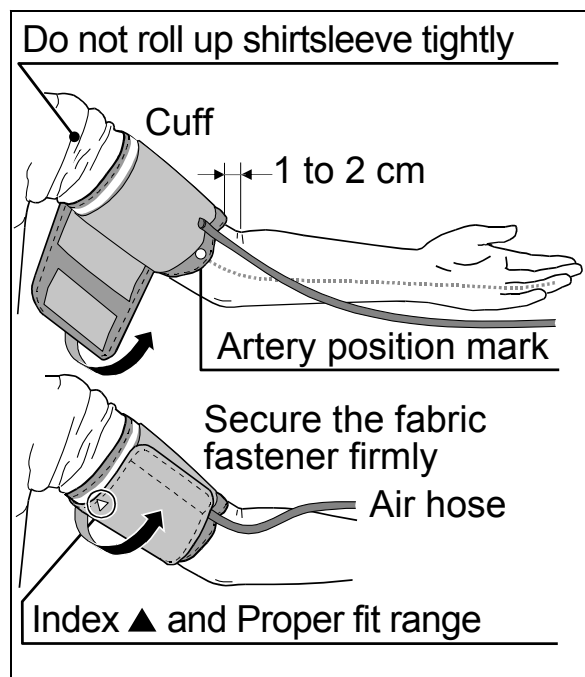

How to Take Accurate Measurements

For the most accurate blood pressure measurement:

- Sit comfortably on a chair. Rest your arm on the table. Do not cross your legs. Keep your feet on the floor and straighten your back.
- Relax for about five to ten minutes before measurement.
- Place the center of the cuff at the same height as your heart.
- Remain still and keep quiet during measurement.
- Do not measure immediately after physical exercise or a bath. Rest for twenty or thirty minutes before taking the measurement.
- Try to measure your blood pressure at the same time every day.

Measurement

During measurement, it is normal for the cuff to feel very tight. (Do not be alarmed)

After Measurement

After measurement, press the **START** button to turn off the power. Remove the cuff and record your data.

Note: The device has an automatic power shut-off function, which turns the power off approximately one minute after measurement. Allow at least three minutes between measurements on the same person.

Measurements

Before measurement, read “Notes for Accurate Measurement” on the next page.

Normal Measurement

1. Place the cuff on the arm (preferably the left arm).
Sit quietly during measurement.

2. Press the **START** button.
All of the display segments are displayed. Zero is displayed blinking briefly. Then the display changes, as indicated in the figure at the right, as the measurement begins. The cuff starts to inflate. It is normal for the cuff to feel very tight. A pressure bar indicator is displayed, as in the figure at the right, during inflation.

Note: If you wish to stop inflation at any time, press the **START** button again.

3. When inflation is complete, deflation starts automatically and the ♥ (heart mark) blinks, indicating that the measurement is in progress. Once the pulse is detected, the mark blinks with each pulse beat.

Note: If an appropriate pressure is not obtained, the device starts to inflate again automatically.

4. When the measurement is complete, the systolic and diastolic pressure readings and pulse rate are displayed. The cuff exhausts the remaining air and deflates completely.
5. Press the **START** button again to turn off the power.

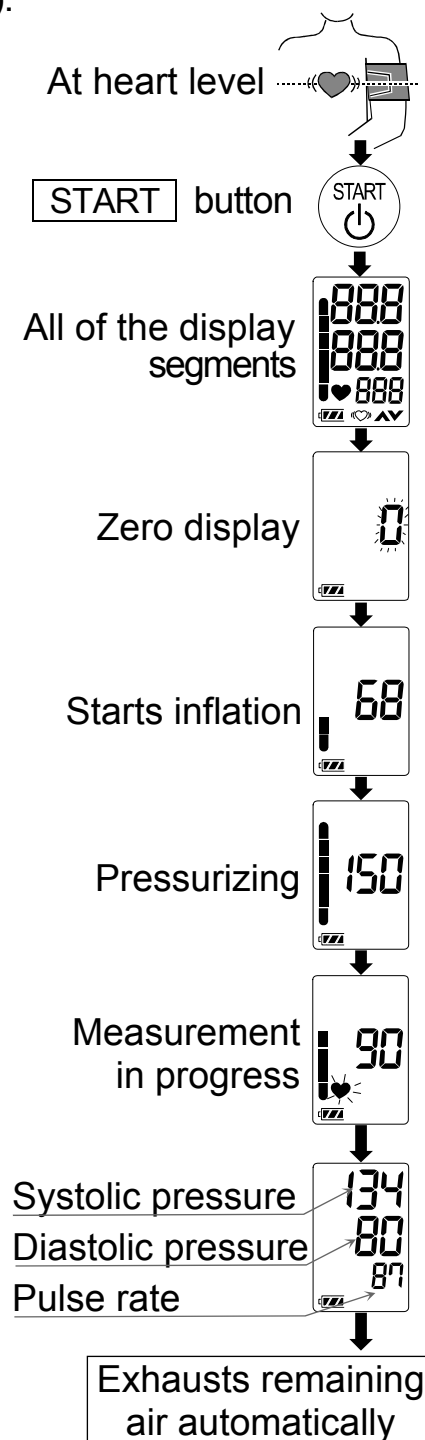

Note: Model UA-651BLE is provided with an automatic power shut-off function. Allow at least three minutes between measurements on the same person.

Measurements

Measurement with the Desired Systolic Pressure

Model UA-651BLE is designed to detect the pulse and to inflate the cuff to a systolic pressure level automatically.

If re-inflation occurs repeatedly or your systolic blood pressure is expected to exceed 230 mmHg, use the following method.

1. Place the cuff on the arm (preferably the left arm).
2. Press the **START** button.
3. While the zero blinks, press and hold the **START** button until a number about 30 to 40 mmHg higher than your expected systolic pressure appears.
4. When the desired number is reached, release the **START** button to start measurement. Then continue to measure your blood pressure as described on the previous page.

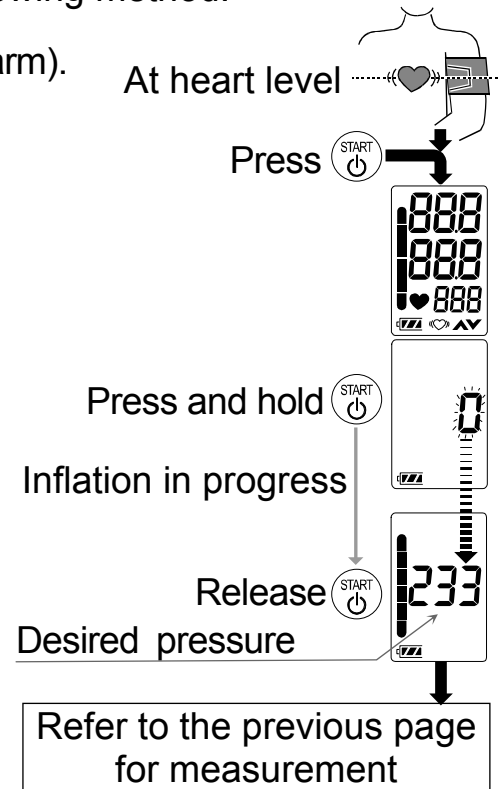

Notes for Accurate Measurement

- ❑ Sit down in a comfortable position. Place your arm on a table with your palm facing upward and the cuff at the same level as your heart.
- ❑ Relax for about five or ten minutes before taking a measurement. If you are excited or depressed by emotional stress, the measurement will reflect this stress as a higher (or lower) than normal blood pressure reading and the pulse reading will usually be faster than normal.
- ❑ An individual's blood pressure varies constantly, depending on what you are doing and what you have eaten. What you drink can have a very strong and rapid effect on your blood pressure.
- ❑ This device bases its measurements on the heartbeat. If you have a very weak or irregular heartbeat, the device may have difficulty determining your blood pressure.
- ❑ Should the device detect a condition that is abnormal, it will stop the measurement and display an error symbol. See page 7 for the description of the symbols.
- ❑ This blood pressure monitor is intended for use by adults. Consult with your physician before using this device on a child. A child should not use this device unattended.

- The automatic blood pressure monitor's performance may be affected by excessive temperature or humidity, or altitude.

What Is The IHB/AFib Indicator?

When the monitor detects an irregular rhythm during the measurements, the IHB/AFib indicator will appear on the display with the measurement values.

Note: We recommend contacting your physician if you see this «♥» IHB/AFib indicator frequently.

What Is The AFib?

The heart contracts due to electrical signals occurring in heart and sends blood through the body. Arterial fibrillation (AFib) occurs when the electrical signal in the atrium becomes confused and leads to disturbances in the pulse interval. AFib can cause blood to stagnate in the heart, which can easily create clots of blood, a cause of stroke and heart attack.

Pressure Bar Indicator

The indicator monitors the progress of pressure during measurement.



About Blood Pressure

What is Blood Pressure?

Blood pressure is the force exerted by blood against the walls of the arteries. Systolic pressure occurs when the heart contracts. Diastolic pressure occurs when the heart expands. Blood pressure is measured in millimeters of mercury (mmHg). One's natural blood pressure is represented by the fundamental pressure, which is measured first thing in the morning while one is still at rest and before eating.

What is Hypertension and How is it Controlled?

Hypertension, an abnormally high arterial blood pressure, if left unattended, can cause many health problems including stroke and heart attack. Hypertension can be controlled by altering lifestyle, avoiding stress, and with medication under a doctor's supervision.

To prevent hypertension or keep it under control:

- Do not smoke
- Reduce salt and fat intake
- Maintain proper weight
- Exercise regularly
- Have regular physical checkups

Why Measure Blood Pressure at Home?

Blood pressure measured at a clinic or doctor's office may cause apprehension and can produce an elevated reading, 25 to 30 mmHg higher than that measured at home. Home measurement reduces the effects of outside influences on blood pressure readings, supplements the doctor's readings and provides a more accurate, complete blood pressure history.

WHO Blood Pressure Classification

Standards to assess high blood pressure, without regard to age, have been established by the World Health Organization (WHO), as shown in the chart.

Reference Material: Journal of Hypertension 1999, Vol 17 No.2

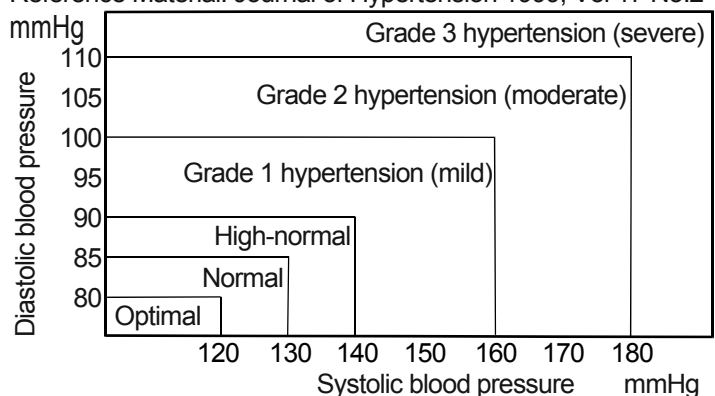

Blood Pressure Variations

An individual's blood pressure varies greatly on a daily and seasonal basis. It may vary by 30 to 50 mmHg due to various conditions during the day. In hypertensive individuals' variations are even more pronounced. Normally, the blood pressure rises while at work or play and falls to its lowest levels during sleep. So, do not be overly concerned by the results of one measurement.

Take measurements at the same time every day using the procedure

described in this manual to get to know your normal blood pressure. Regular readings give a more comprehensive blood pressure history. Be sure to note date and time when recording your blood pressure. Consult your doctor to interpret your blood pressure data.

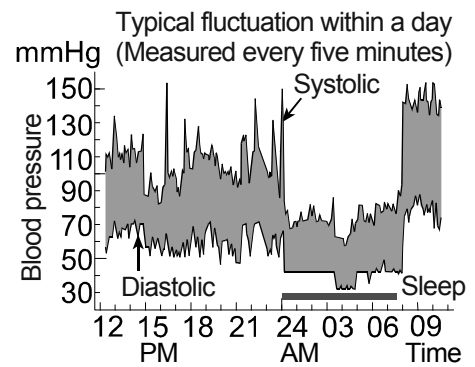

Troubleshooting

Problem	Possible Reason	Recommended Action
Nothing appears in the display, even when the power is turned on.	Batteries are drained.	Replace all batteries with new ones.
	Battery terminals are not in the correct position.	Reinstall the batteries with negative and positive terminals matching those indicated on the battery compartment.
The cuff does not inflate.	Battery power is low.  (LOW BATTERY mark) blinks. If the batteries are drained completely, the mark does not appear.	Replace all batteries with new ones.
The device does not measure. Readings are too high or too low.	The cuff is not applied properly.	Apply the cuff correctly.
	You moved your arm or body during measurement.	Make sure you remain very still and quiet during measurement.
	The cuff position is not correct.	Sit comfortably and still. Place your arm on a table with your palm facing upward and the cuff at the same level as your heart.
	_____	If you have a very weak or irregular heart beat, the device may have difficulty in determining your blood pressure.
Other	The value is different from that measured at a clinic or doctor's office.	See "Why measure blood pressure at home?"
	_____	Remove the batteries. Place them back properly and try the measurement again.

Note: If the actions described above do not solve the problem, contact the dealer. Do not attempt to open or repair this product, as any attempt to do so will make your warranty invalid.

Maintenance

Do not open the device. It uses delicate electrical components and an intricate air unit that could be damaged. If you cannot fix the problem using the troubleshooting instructions, request service from your dealer or from the A&D service group. The A&D service group will provide technical information, spare parts and units to authorized dealers.

The device was designed and manufactured for a long service life. However it is generally recommended to have the device inspected every 2 years, to ensure proper functioning and accuracy. Please contact the authorized dealer in your area or A&D for maintenance.

Technical Data

Type	UA-651BLE
Measurement method	Oscillometric measurement
Measurement range	Pressure: 0 - 299 mmHg Systolic pressure: 60 - 279 mmHg Diastolic pressure: 40 - 200 mmHg Pulse: 40 - 180 beats / minute
Measurement accuracy	Pressure: ± 3 mmHg Pulse: $\pm 5\%$
Power supply	4 x 1.5V batteries (LR6, R6P or AA) or AC adapter (TB-233C) (Not included)
Number of measurements	Approx. 700 times LR6 (alkaline batteries) Approx. 200 times R6P (manganese batteries) With pressure value of 180 mmHg at room temperature of 23 °C.
Classification	Internally powered ME equipment (Supplied by batteries) /Class II (Supplied by adapter) Continuous operation mode
Clinical test	According to ISO81060-2 : 2013
EMD	IEC 60601-1-2: 2014
Wireless communication	VZ (MURATA Manufacturing Co. Ltd.) Bluetooth Ver.4.0LE BLP Frequency band: 2402 MHz to 2480 MHz Maximum RF output power: 1.6 dBm Modulation:GFSK
Operating conditions	+10 to +40 °C / 15 to 85 %RH / 800 to 1060 hPa
Transport / Storage conditions	-20 to +60 °C / 10 to 95 %RH / 700 to 1060 hPa
Dimensions	Approx. 96 [W] x 68 [H] x 130 [D] mm
Weight	Approx. 250 g, excluding batteries

Applied part Cuff Type BF 

Useful life Device: 5 years (when used six times a day)
 Cuff: 2 years (when used six times a day)
 AC adapter: 5 years (when used six times a day)







Ingress protection Device: IP20

Accessory AC adapter The adapter is to connect the blood pressure monitor to a power source at home.

TB-233C

Please contact your local A&D dealer for purchasing.
 The AC adapter is required to be inspected or replaced periodically.

Symbols that are printed on the AC adapter

Symbols	Function / Meaning
	For indoor use only
	Class II device
	Thermal fuse
	Fuse
	EC directive device label
	EAC certification device label
	Polarity of AC adapter plug

Accessories sold separately

Cuff

Catalog Number	Cuff Size	Arm Size
CUF-F-LA	Large adult cuff	31 cm to 45 cm
CUF-F-A	Adult cuff	22 cm to 32 cm

AC adapter

Catalog Number	Plug
TB-233C	Type C

Note: Specifications are subject to change for improvement without prior notice.
 IP classification is the degrees of protection provided by enclosures in accordance with IEC 60529. This device is protected against solid foreign objects of 12 mm diameter and greater such as a fingers. This device is not protected against water.



A&D Company, Ltd.

1-243 Asahi , Kitamoto-shi, Saitama 364-8585, JAPAN
Telephone: [81] (48) 593-1111 Fax: [81] (48) 593-1119

EC REP

Emergo Europe B.V.

Prinsessegracht 20, 2514 AP The Hague, The Netherlands
Tel: [31] (70) 345-8570 Fax: [31] (70) 346-7299

A&D INSTRUMENTS LIMITED

Unit 24/26 Blacklands Way, Abingdon Business Park, Abingdon, Oxfordshire OX14 1DY
United Kingdom
Telephone: [44] (1235) 550420 Fax: [44] (1235) 550485

A&D ENGINEERING, INC.

1756 Automation Parkway, San Jose, California 95131, U.S.A.
Telephone: [1] (408) 263-5333 Fax: [1] (408)263-0119

A&D AUSTRALASIA PTY LTD

32 Dew Street, Thebarton, South Australia 5031, AUSTRALIA
Telephone: [61] (8) 8301-8100 Fax: [61] (8) 8352-7409

ООО A&D RUS

ООО "ЭЙ энд ДИ РУС"

121357, Российская Федерация, г.Москва, ул. Верейская, дом 17
(Business-Center "Vereyskaya Plaza-2" 121357, Russian Federation, Moscow, Vereyskaya Street 17)
тел.: [7] (495) 937-33-44 факс: [7] (495) 937-55-66

A&D Technology Trading(Shanghai) Co. Ltd 爱安德技研贸易(上海)有限公司

中国 上海市浦东新区浦东大道138号永华大厦21楼A室 邮编200120
(21F Room A, Majesty Building, No.138 Pudong Avenue, Pudong New Area, Shanghai, 200120, China)
电话: [86] (21) 3393-2340 传真: [86] (21) 3393-2347

A&D INSTRUMENTS INDIA PRIVATE LIMITED ऐंडी इन्स्ट्रुमेन्ट्स इण्डिया प्रा० लिमिटेड

509, उद्योग विहार , फेस -5, गुडगांव - 122016, हरियाणा , भारत
(509, Udyog Vihar, Phase-V, Gurgaon - 122 016, Haryana, India)
फोन : 91-124-4715555 फैक्स : 91-124-4715599

